

CIMCO MDC-MAX

COLLECTS AND ANALYZES SHOP FLOOR PRODUCTIVITY

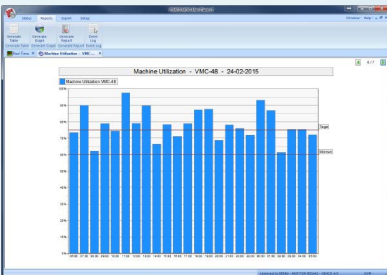
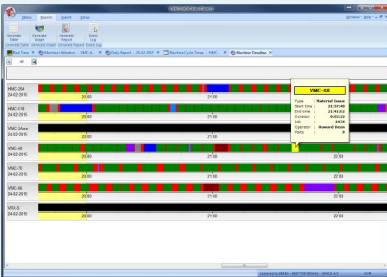

INCREASE PRODUCTIVITY

WHETHER YOU WANT TO INCREASE YOUR EXISTING LEVEL OF PRODUCTIVITY, IDENTIFY PRODUCTION BOTTLENECKS OR STREAMLINE WORKFLOW CIMCO MDC-MAX IS THE SOLUTION OF CHOICE

Production is not flowing as it should. You have problems keeping up with demand, too much waste, too much machine downtime, tooling costs are too high and you have no real idea what to change or where to start.

Problems like these can be complicated and there are often many attributing factors. You may be forced to analyze your entire production process in order to know what causes a specific problem. Even then, you will have a snapshot of your production that takes hours or even days of work to create.

With CIMCO MDC-Max you get a full representation of your production. You will have real-time monitoring of your entire production operation and every second is recorded so you can easily examine the data and pinpoint bottlenecks. MDC-Max will provide information on the entire shop floor every second of the day allowing you to clearly identify and prioritize the changes needed.

A COMPLETE MDC SOLUTION

CIMCO MDC-Max is a complete MDC solution that benefits the one man operation with a few machines and the corporate enterprise with multiple factories. The MDC-Max software is highly flexible and easily customized to fit your current and future data collection needs.

CIMCO MDC-Max analyzes the data it collects and presents a variety of statistics and reports. This information can be directed to smartphones, tablets and TV-screens for real-time monitoring of your production. Since MDC-Max is a networked solution that stores data on a central server you can monitor production from multiple locations and access the data from anywhere.

WHY INVEST

MANUFACTURING PROBLEM FOUND WITHIN 24 HOURS OF INSTALLATION

CIMCO MDC-Max was recently installed at a customer site that had tooling cost issues. The production director had only recently taken over the management of the shop floor and felt that the tooling costs were too high.

CIMCO MDC-Max was installed and collecting data before the night shift arrived. The next morning the production director checked the monitoring data collected from the machines and immediately had his answer. The night shift cycle times for 4 machines were 30% less than the cycle times during the day and the same machines were stopped for over an hour at the end of the shift. The operators had turned up the feed rates, but the increased feed rates resulted in poor tool tip life and increased tooling costs. The customer now has reduced tooling costs while still achieving the same production schedules and said that the system will pay for itself in a matter of months.

CIMCO MDC-MAX TRACKS REASONS FOR MACHINE DOWN TIME

A large aerospace contractor was concerned that their production was not keeping up with demand and had made the decision to buy several additional machines. It was suggested that they check the runtime clocks on the machines for a week to see how much production time was being achieved. They were astonished to find that their machine utilization was below 50% but could not get an accurate picture of why this was happening.

CIMCO MDC-Max was installed to monitor the machines along with bar code readers for the operators to swipe downtime codes. MDC highlighted several problems in production, two of which were poor maintenance response and failure to replace tooling quickly enough to get the machine back in production.

Following the MDC-Max installation the customer implemented several measures including a priority system for maintenance and availability of new pre-set tools. They now achieve overall machine utilization of over 68% and meet their production targets which has increased profitability so they can now invest in a new plant.

HOW DOES IT WORK?

DATA COLLECTION

When we talk about data what we actually mean is events. The first task when installing CIMCO MDC-Max is to consider what *machine* and *operator events* you want to collect information about.

Machine events can be collected automatically by CIMCO MDC-Max and most installations will include events such as Cycle Start, Cycle Stop, and Part Complete as a minimum. When these events occur at a machine CIMCO MDC-Max is automatically notified and data about the event is stored.

Operator event data is sent manually by machine operators. Using a smartphone, tablet, barcode scanner or PC an operator at a machine can send status information to CIMCO MDC-Max indicating specific events. Usually you want to collect downtime reasons such as Waiting for Setup, Waiting for Maintenance, Scrapped Part, Inspection, etc. CIMCO MDC-Max can be customized to collect specific information on any event.

ALL EVENT DATA
SECURELY STORED ON SERVER

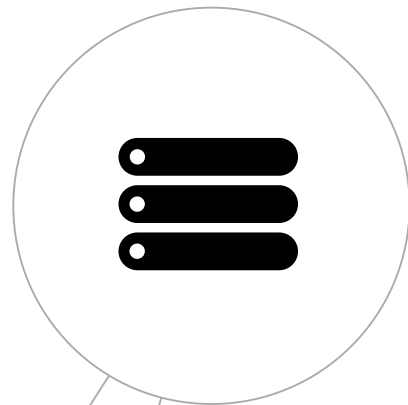

MACHINE AND OPERATOR EVENTS ARE SENT TO SERVER USING NETWORK

OPERATOR WITH MOBILE DEVICE USING WEB CLIENT FOR FEEDBACK

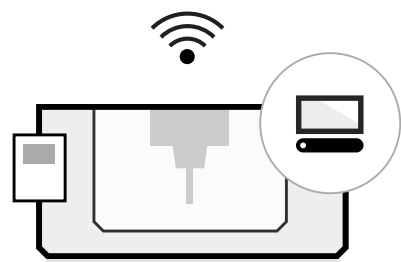

MACHINE #1 EQUIPPED WITH MINI PC FOR OPERATOR FEEDBACK

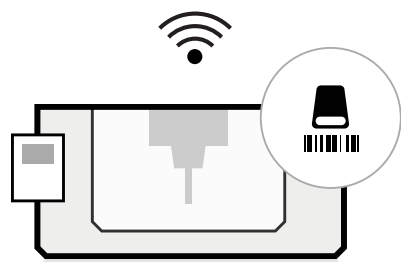

MACHINE #2 EQUIPPED WITH BARCODE READER FOR OPERATOR FEEDBACK

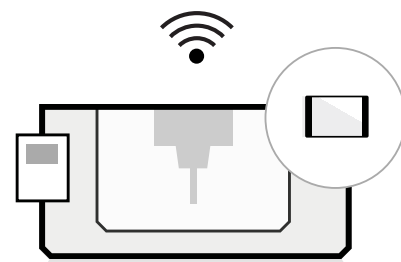

MACHINE #3 EQUIPPED WITH TABLET FOR OPERATOR FEEDBACK

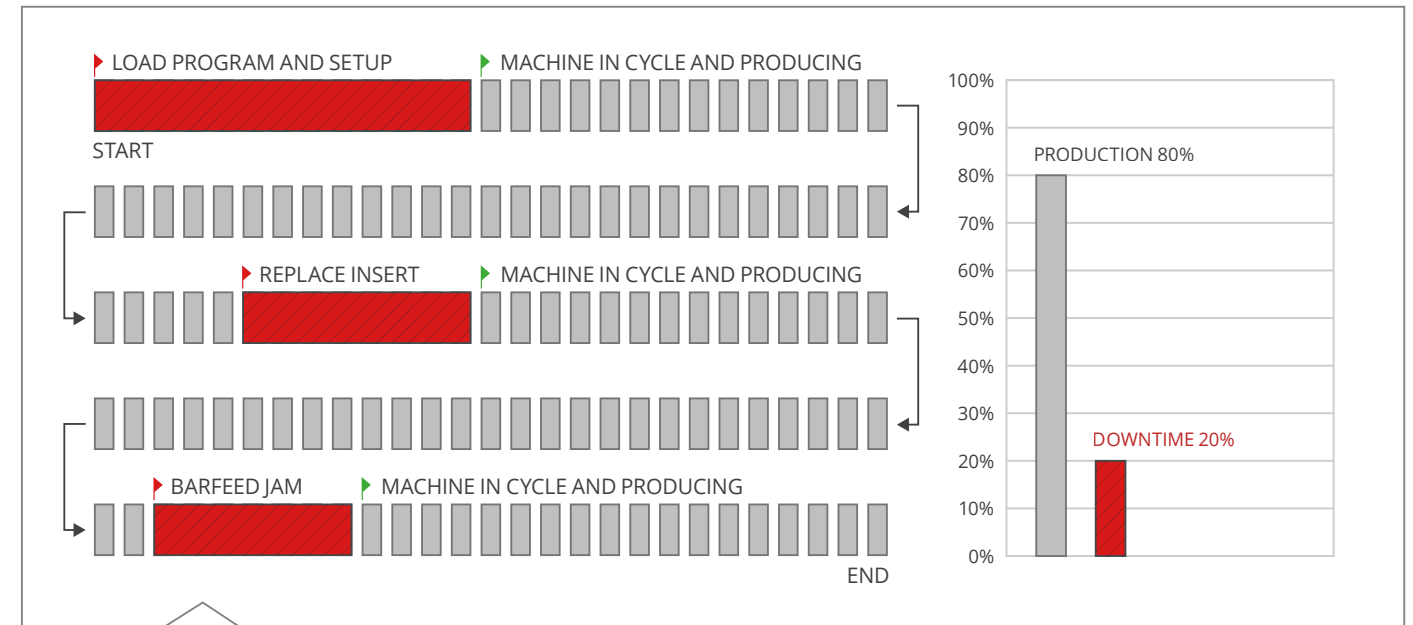

BASIC SETUP FOR MACHINE DATA COLLECTION

The majority of companies only want to know if a particular machine is running and producing parts or if it is stopped. With a basic data collection setup MDC-Max can show the amount of time the machine has been in production and the amount of time allocated to downtime.

ADVANCED SETUP FOR MACHINE DATA COLLECTION

With the advanced data collection option MDC-Max can provide accurate reporting of machine tool efficiency on any job. MDC-Max can show the total percentage of downtime for each type of machine stoppage such as Tooling, Setup, Machine Maintenance, etc. This additional information is provided by the operator using a tablet or a barcode scanner. The operator uses the tablet or simply scans a barcode to indicate the downtime reason. This information can then be used to pinpoint exactly what is causing a loss of production.

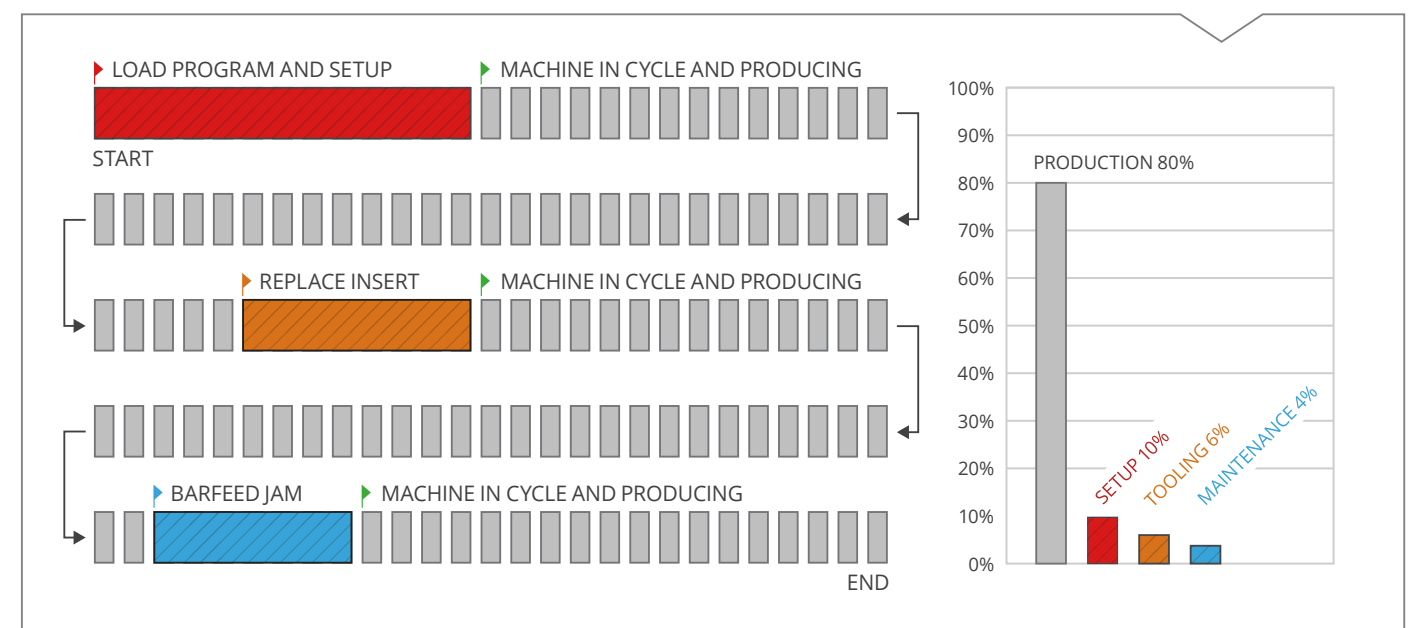

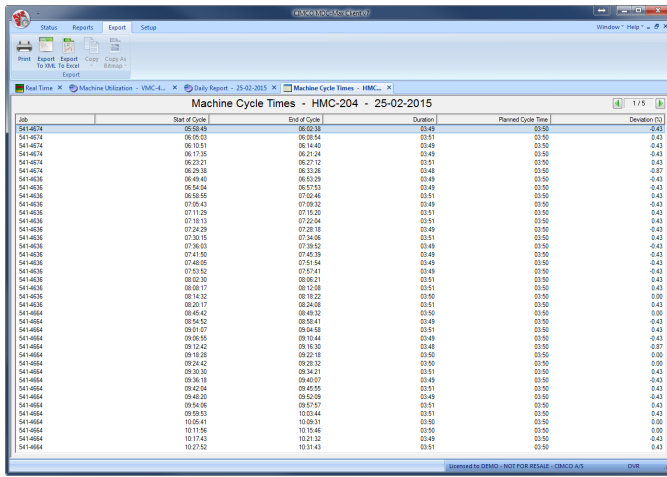

Utilization by cycle time, duration and deviation

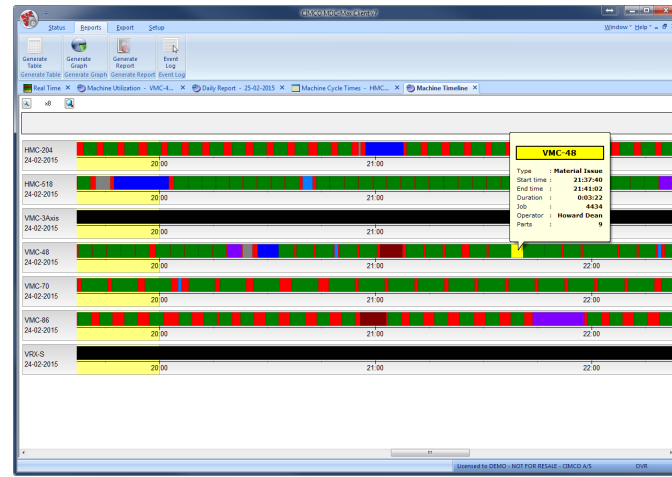

Machine utilization visualized as timeline



Live screen positioned to be viewable by the entire shop

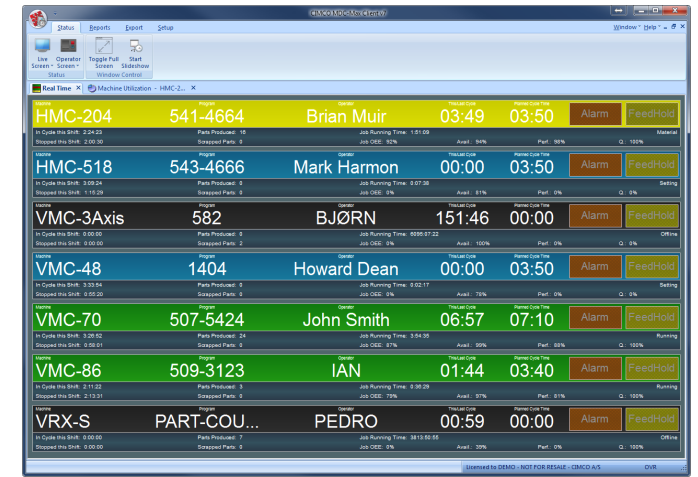

Real-time machine status

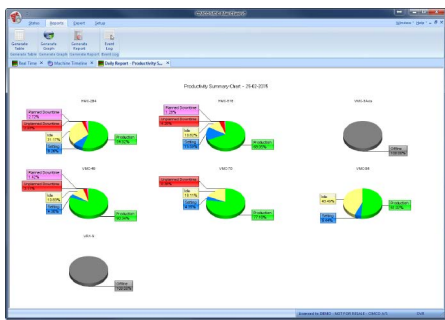

Productivity summary chart

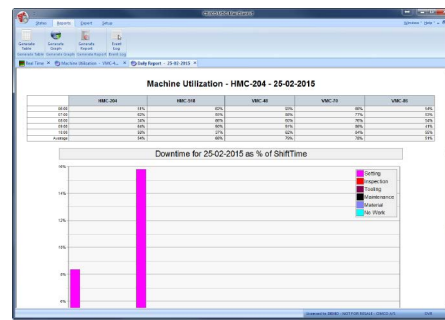

Utilization and downtime combined

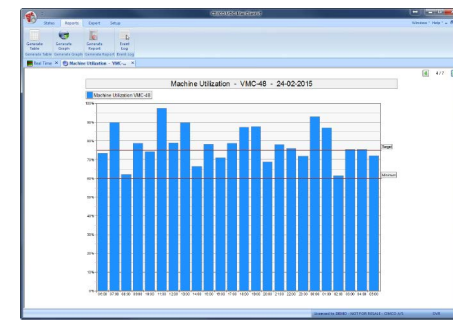

Hourly machine utilization

REPORTS AND GRAPHS

In CIMCO MDC-Max data is structured and visualized as reports. You can setup MDC-Max to generate both real-time and historic reports based on the data collected. MDC-Max features a modern tabbed interface where each open report is shown in a separate tab. This maximizes screen space for each report while allowing many reports to be open and updating in the background.

MDC-Max comes with built-in reports, but the true power lies in its ability to create customized reports. Visualize data as tables, pie or bar charts, add in production targets, work shifts, calculate key performance indicators such as OEE, MTBF, MTR, and more. You can also generate event logs chronologically by operator, machine, and job to know exactly how each machine and operator is performing.

MDC-Max supports dynamic reporting where data is updated in real-time. Machine status can be visualized as timelines or Gantt charts with status changes shown with different bar colors so you can see at a glance what is going on.

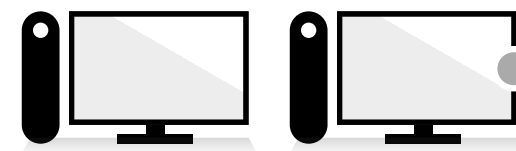

DATA IS ANALYSED AND PRESENTED AS REPORTS IN THE CIMCO MDC-MAX CLIENT

EXAMPLES

- Cycle time per part (min, max and average)
- Number of parts per shift/operator
- Number of scrapped parts
- Machine downtime
- Scheduled maintenance
- Unscheduled maintenance
- Setup time per part
- Operator effectiveness
- Overall Equipment Effectiveness (OEE)
- Mean time between failures (MTBF)
- Mean time to repair (MTTR)

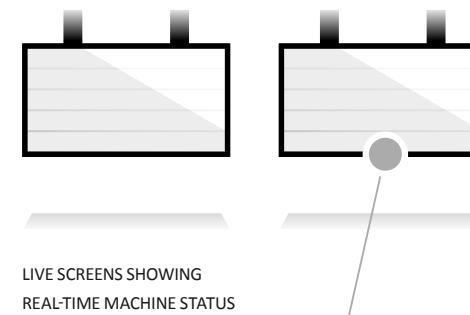

LIVE SCREENS SHOWING REAL-TIME MACHINE STATUS

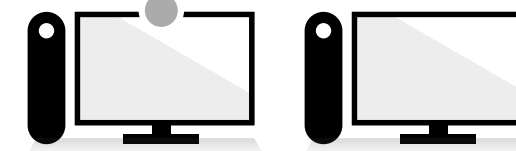
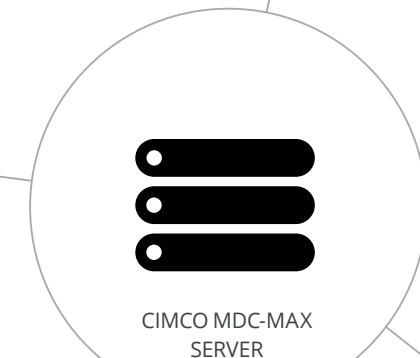

DYNAMIC REPORTS SHOW MACHINE STATISTICS IN REAL-TIME

REAL-TIME MONITORING

One of the unique features of CIMCO MDC-Max is our Live Screen which provide a great status overview for every machine and can be displayed on large plasma or LCD screens. This Live Screen can be configured to show a list of all machines and their current status. Further, data such as machine name, job name, part count, running time, downtime, etc. can be associated with each machine to provide a complete overview.

The Live Screen is normally displayed on large screens that are installed in convenient locations so that all personnel can easily see the status of each machine. However, it can also be displayed on smartphones, tablets, and touch screens using the MDC-Max Web Client and can thereby be viewed from anywhere there is an internet connection.

If machines are running unattended MDC-Max can even be configured to send an email and a text message to a stand-by operator's or supervisor's smartphone if a machine stops.

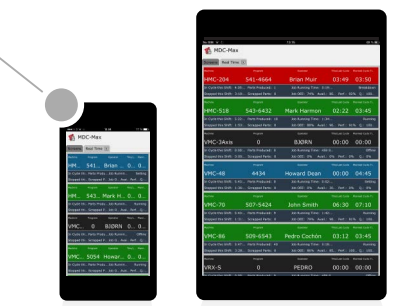

SEE MACHINE STATUS FROM ANYWHERE WITH THE MDC-MAX WEB CLIENT ON MOBILE DEVICES

HANDHELD OPTIONS

MDC-MAX WEB CLIENT

With the MDC-Max Web Client we have taken operator events to the next level. The web client can display your live screens and be customized to send any operator event you can think of. Machine status and operator events can be accessed directly in the web client interface making it extremely easy for operators to send downtime reasons for a specific machine.

The web client is optimized for even the smallest displays using responsive design techniques. This means you can access the same interface on smartphones, tablets, and PCs. Thereby the traditional operator screen at the machine has become mobile and can fit in every operator's pocket. This is not only convenient for the operator, but also a cost-efficient alternative to having client PCs or bar code readers installed at each machine.

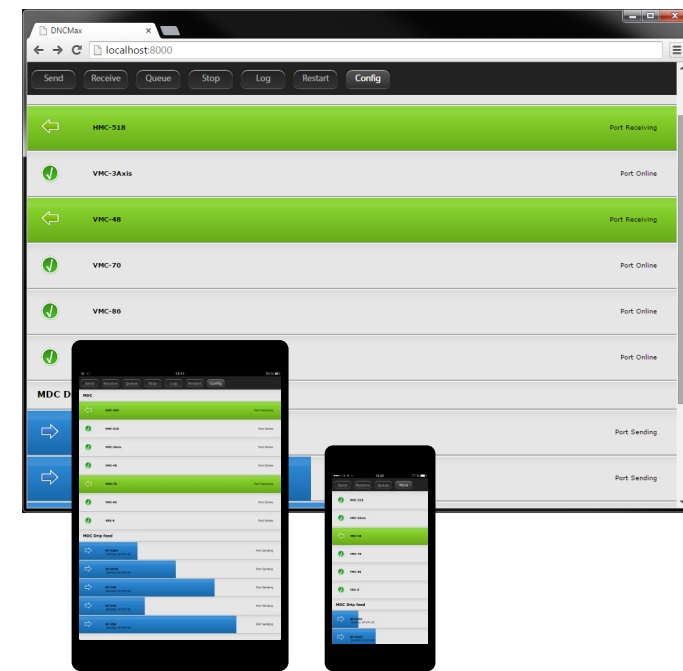
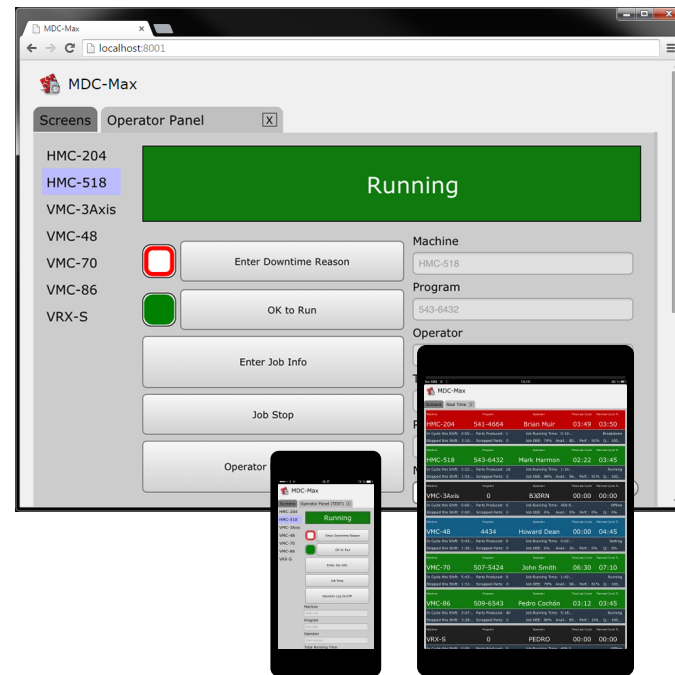

DNC-MAX WEB CLIENT

CIMCO's innovative DNC software includes a new web client that can be accessed from any mobile device or PC.

The DNC-Max Web Client can display the current program transfer progress and state of all your machines. You can send, receive, and preview CNC programs using a built-in file browser showing your files on the DNC-Max Server - just like with our regular DNC-Max PC client. It is even possible to stop transmission of programs, restart ports, and also remove programs from the transmission queue directly from the web interface.

Please contact us for more information about how CIMCO DNC-Max can seamlessly integrate with your MDC-Max solution.

SYSTEM INTEGRATION

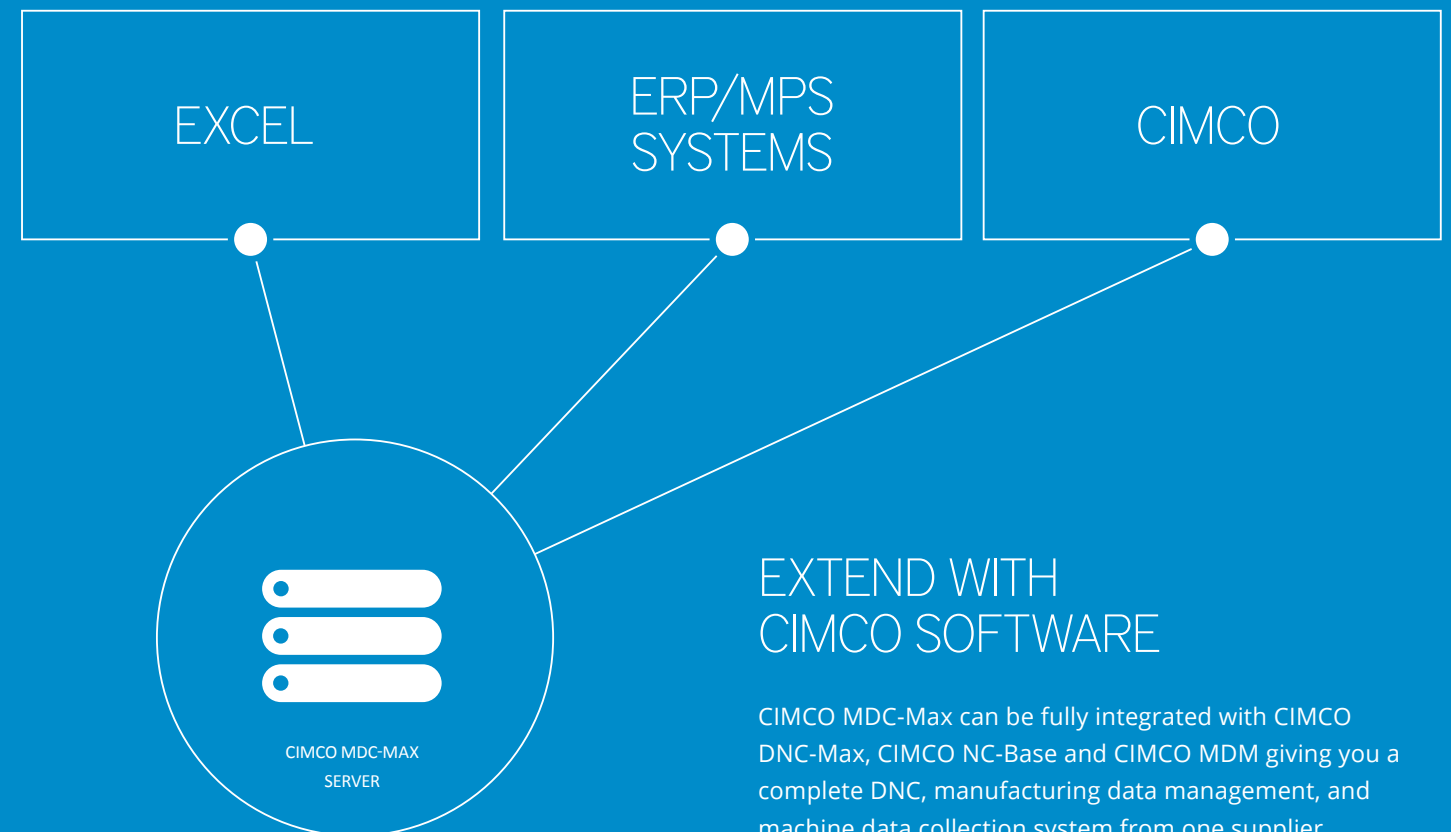

EXTEND WITH CIMCO SOFTWARE

CIMCO MDC-Max can be fully integrated with CIMCO DNC-Max, CIMCO NC-Base and CIMCO MDM giving you a complete DNC, manufacturing data management, and machine data collection system from one supplier.

CIMCO DNC-Max controls CNC program transfer to all of your machines. Programs can be requested directly from the machine control - operators do not need to leave the control to download programs. A program that is changed and uploaded by the operator can automatically become the active version of the program while storing the previous version as a backup copy of the file or the uploaded file can be stored in a quarantine area. This offers the ability to track changes and revert to any previous version if necessary.

CIMCO NC-Base and CIMCO MDM are both full featured manufacturing data management systems that help you manage, control and securely store your manufacturing related data. While CIMCO NC-Base is ideal for handling your NC-programs and related documents, CIMCO MDM can be customized to handle any kind of data such as CAD/CAM programs and any related documents.

INTEGRATION WITH OTHER SYSTEMS

CIMCO MDC-Max comes with full support for Microsoft Excel spreadsheets. Reports can be exported easily for further analysis in Excel. MDC-Max can even update your Excel spreadsheet automatically, so the latest data is always available.

CIMCO MDC-Max can also be integrated with most ERP/MPS systems on the market. This means you can have a completely integrated solution that can significantly reduce administrative tasks.

Please contact us for more information about how CIMCO MDC-Max can be integrated with your software systems.

Please contact us for more information about our other software products or learn more at CIMCO.COM.

NETWORK OPTIONS

CIMCO MDC-Max can easily be added to your existing network supporting a variety of hardware options including serial wiring, Ethernet or a wireless networking. MDC-Max collects information from machines connected to your

network either directly or using additional hardware. The data collection method depends on your specific type of machine and its monitoring capabilities.

DIRECT CONNECTION

If the machine you wish to monitor has one of the data collection interfaces available (see table below), a direct connection can be achieved by simply connecting an Ethernet cable to the machine. In this case no additional hardware is required beyond what might be needed for operator input (e.g. tablet). However, it can be costly to activate or install the monitoring feature if not enabled on a machine control and the option below might be preferred.

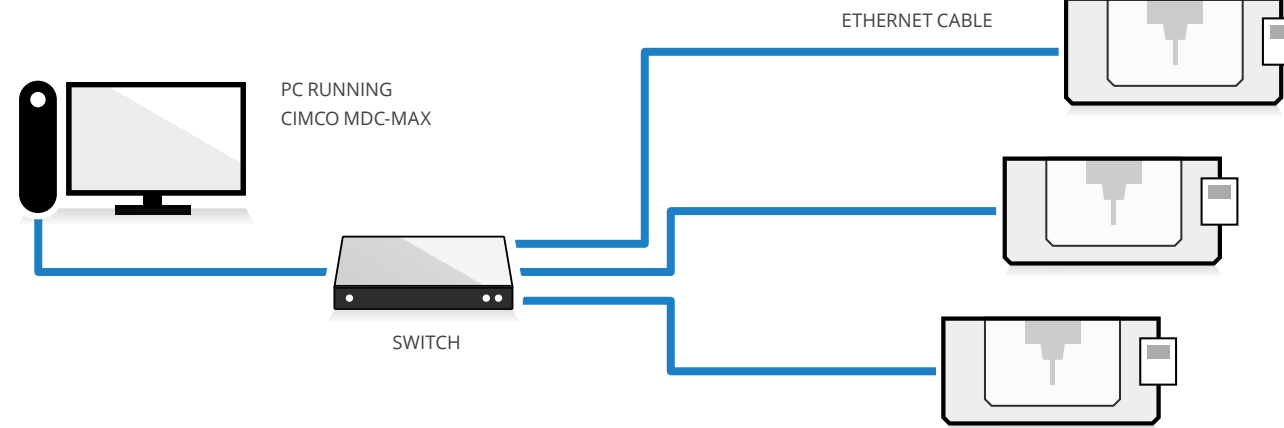

HARDWARE CONNECTION

If your machine does not support one of the monitoring interfaces signals can be acquired from the machine using an input device such as the MDC-Box or Moxa ioLogik device. These devices handle the connection between your machine and network and facilitate signal transmission, in the form of machine event data, to MDC-Max.

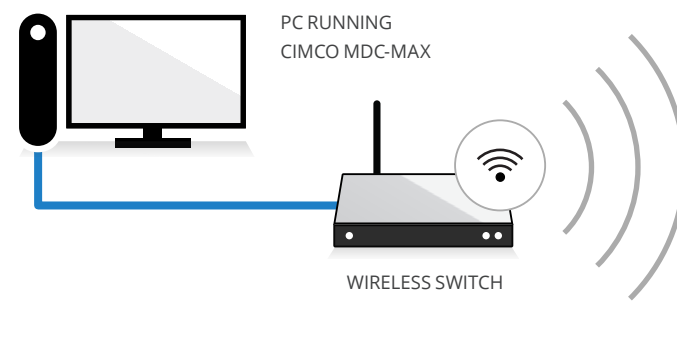

ETHERNET NETWORK

Many manufacturing facilities are networked, with Ethernet available at each machine. Standard Ethernet hardware (switches, routers, bridges, etc.) are used to connect the machines to the network.

EXAMPLE OF ETHERNET NETWORK WITH DIRECT CONNECTION TO MACHINES

WIRELESS NETWORK

Wireless networks on the shop floor are becoming increasingly popular. If you expect to move or add machines a wireless network eliminates the need to run or re-route cables.

EXAMPLE OF WIRELESS NETWORK WITH HARDWARE CONNECTION USING MDC-BOX / MOXA ioLogik

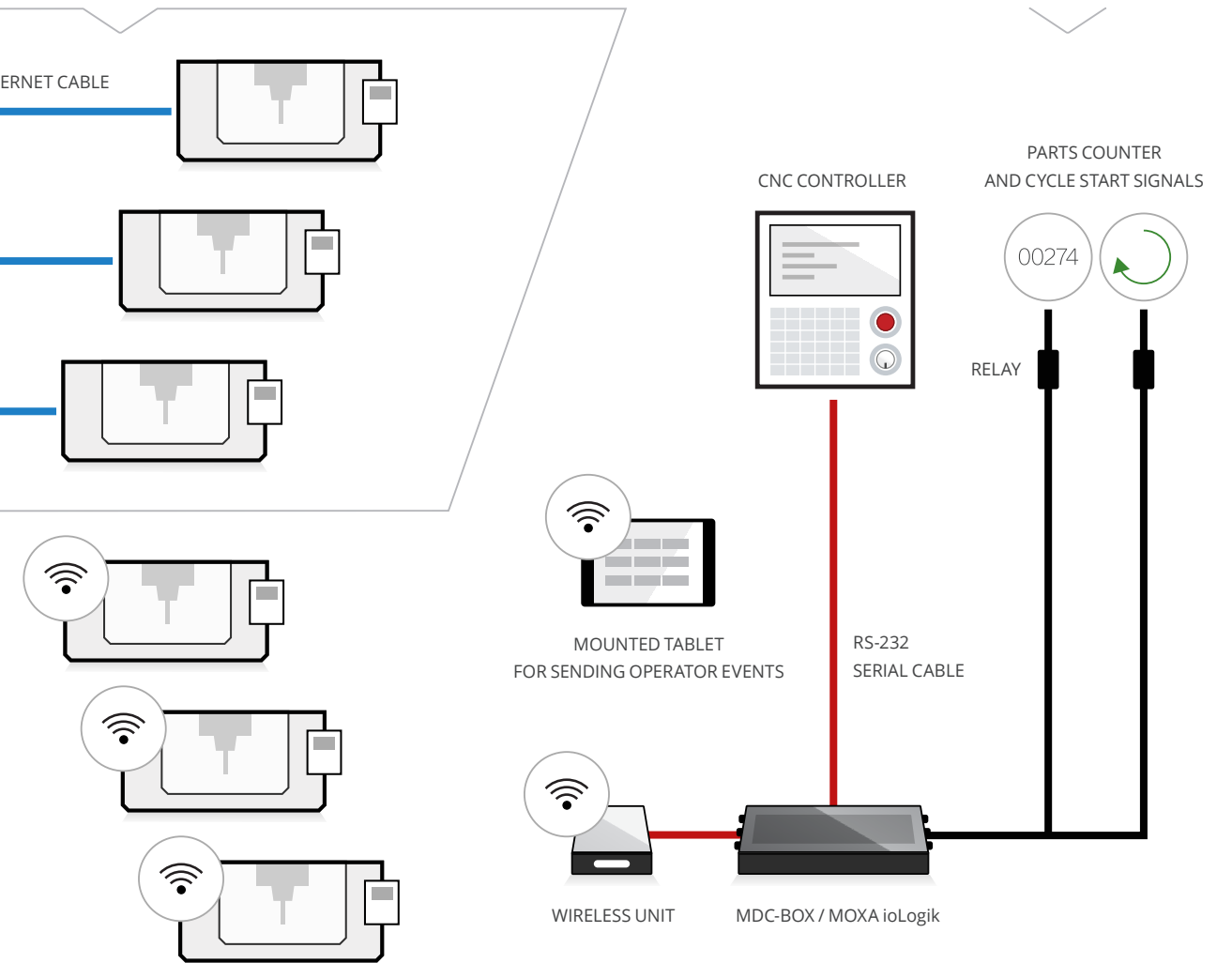

SUPPORTED MACHINE CONTROLS

The machine controls listed are just some of the many controls we support for direct connection. If your control is not listed please contact us for information about your specific machine and control.

Control	Required interface	Extent of data access
Fanuc	FOCAS	Full compatibility
Haas	M-Net	Full compatibility
Mazak	MTConnect	Full compatibility
Okuma	MTConnect	Full compatibility
Mitsubishi	MTConnect	Full compatibility
NUM	MTConnect	Full compatibility
Heidenhain	DNC Opt #18	Full compatibility
Siemens (840D, 810D)	Hardware adapter	Most compatibility

We are continuously adding support for additional machines.

TRADITIONAL NETWORK

In a traditional cabled network serial cables can be run from each machine to a single PC and be connected using a Multiport Communications Card installed in the PC. However, we typically advice to use an Ethernet to RS-232 Port Server instead for connecting PC and machines. This solution is more scalable and modern compared to using a multiport card.

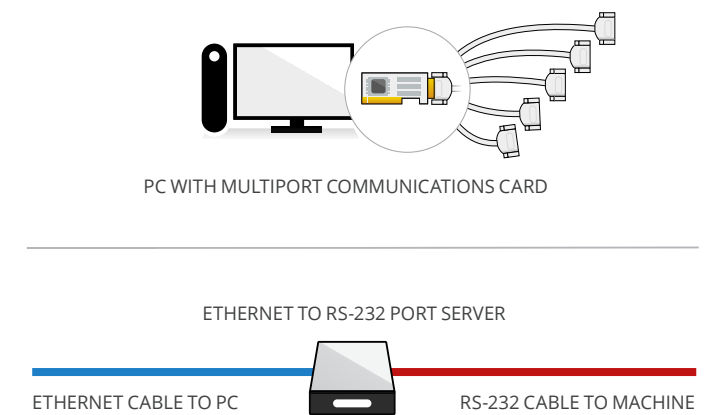

HELPS EVERYBODY IN THE COMPANY

“ I WOULD LIKE TO INSTALL MDC-MAX
BUT I KNOW THERE WILL BE RESISTANCE FROM THE SHOP FLOOR ”

Often shop floor staff is suspicious of monitoring systems as they see them as “big brother” watching them. However, the staff can actually benefit from MDC-Max, since it can highlight problems that have been apparent to them for some time, but of which they have been unable to convince the management.

Recently MDC-Max was installed at a company that was not reaching production targets. The production manager was being pushed to increase production. He had already reported problems with several of the machines that made

it impossible to reach the targets, but nothing had been done. Two weeks after installation the production manager met with the management, and the MDC-Max figures showed conclusively that two machines were indeed causing the backlog in production.

The machines were bar fed machines, and the company had switched to a less expensive material supplier, but these bars were constantly sticking and jamming the machines causing lost production. MDC-Max highlighted this problem and the company changed back to their original supplier.

CIMCO.COM

VISIT OUR WEBSITE FOR MORE INFORMATION ABOUT
CIMCO MDC-MAX AND OUR OTHER SOFTWARE PRODUCTS

 RESELLER

 CONTACT

EUROPE

CIMCO A/S
VERMUNDSGADE 38A
COPENHAGEN, DENMARK

TEL: +45 45 85 60 50
FAX: +45 45 85 60 53
EMAIL: INFO@CIMCO.COM

AMERICAS

CIMCO AMERICAS LLC
651 S SUTTON ROAD, SUITE 276
STREAMWOOD, IL 60107

TEL: +1 704 644 3587
FAX: +1 704 943 0514
EMAIL: INFO@CIMCO.COM